

REFERENCE

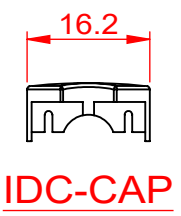

IDC-CAP

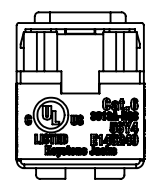
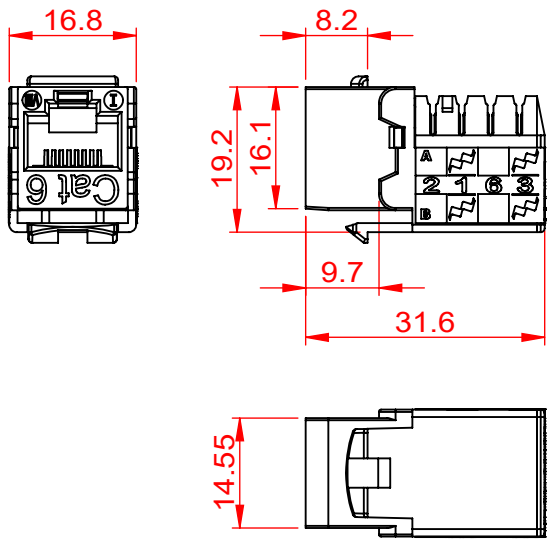
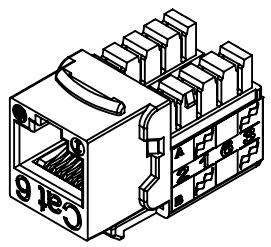
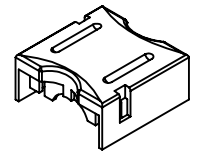
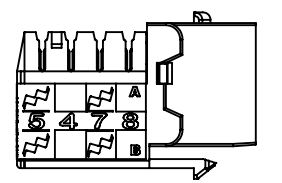

SUGGESTED MOUNTING CUTOUT

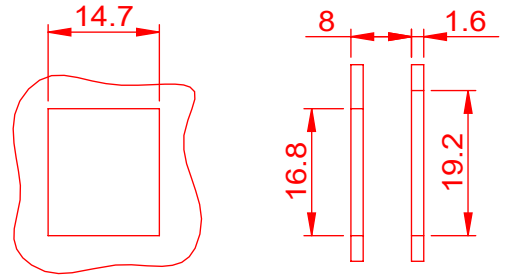

MATERIAL

KEYSTONE JACK HOUSING : ABS,UL94V-0.
 JACK CONTACTS : PHOSPHOR BRONZE,50U" GOLD PLATED.
 IDC PLASTIC : PC,UL94V-0.
 IDC TERMINALS : PHOSPHOR BRONZE,TIN OVER NICKEL UNDERCOAT.

PHYSICAL CHARACTERISTICS

SUITABLE IMPACT TOOL : 110 STYLE PUNCH DOWN TOOL.
 INSERTION LIFE : 750 MATING CYCLES WITH FCC COMPLIANT 8P PLUG.
 CONTACT FORCE : 100 GRAMS WITH FCC COMPLIANT 8P PLUG.
 PLUG RETENTION FORCE : 11 LBF MIN.
 DURABILITY : 200 TERMINATION CYCLES.
 CONTACT COMPATIBILITY : ACCOMMODATES 22 TO 24 AWG SOLID.
 OPERATING TEMPERATURE RANGE : -10°C TO 60°C.
 STORAGE TEMPERATURE RANGE : -40°C TO 68°C.
 HUMIDITY : 10%~90%RH.

ELECTRICAL

INSULATION RESISTANCE : 500 MΩ.
 DIELECTRIC WITHSTANDING VOLTAGE : 1000 V AC.
 DC CURRENT RATING : 1.5 Amps.
 DC RESISTANCE : 0.1Ω.
 CONTACT RESISTANCE : 20mΩ.

NOTE

- * WILL NOT SUPPORT CHANNEL SHORTER THAN 15M.
- * ONLY ACCEPT RJ-45 8P8C PLUG.

ACCORDING TO: ANSI/TIA-568-C.2
 ISO/IEC 11801 2nd Edition
 IEC 60603-7

Cat 6

56Y4
 E145249



COMMUNICATION
 CIRCUIT ACCESSORIES

ENCLOSURE

IDC CAP X 1 PC
 INSTRUCTION X 1 PC

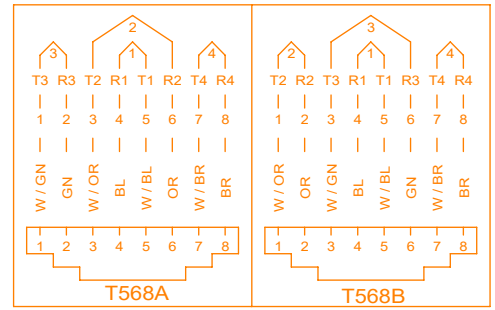

Scale		1:1		All Copy Rights Reserved	
3rd Angle Projection				SCP Structured Cable Products™ Quality Installations Deserve Quality Products	
Unit		mm		Title	
Date		2016/7/19			
Tolerance					
~20	~50	~150	150~	ANGLE	Drawn by NICK
±0.2	±0.4	±0.5	±1.5	±2°	