

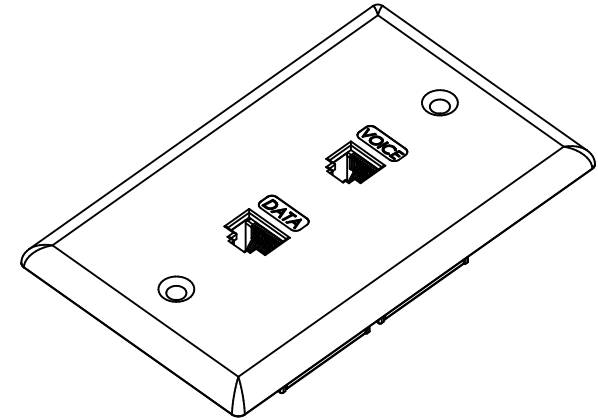

Part Number:	Jacket Color:
122-AL	Almond
122-WT	White

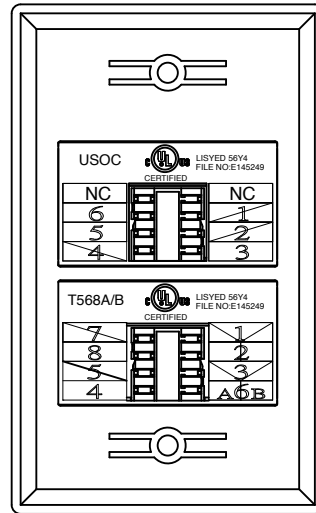
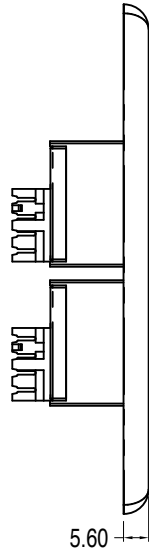
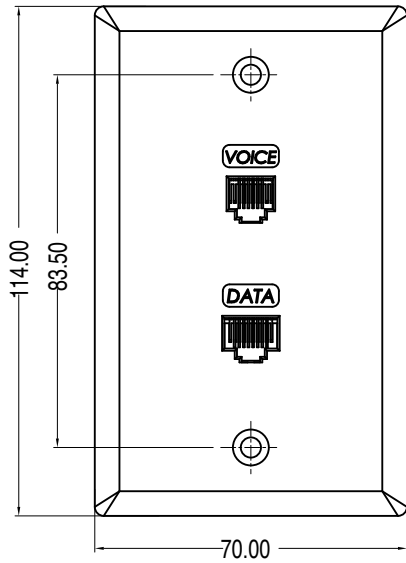
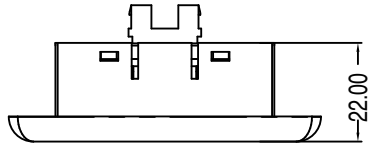

Cat 5e
UL CERTIFIED  **US LISTED**
ACCORDING TO TIA/EIA-568-B-2
REQUIREMENTS
FILE NO.E145249

MATERIAL

Housing: ABS, UL 94V-0
IDC plastic: PC, UL 94V-0
IDC contact: Phospher Bronze with 200u
" Tin over 100u" Nickel undercoat
Spring Wire: Phospher Bronze with 50u
" Gold over 100u" Nickel undercoat
Temperature: -40°C ~ 70 °C
Humidity: 10% ~ 90% RH
Modular jack: 750 mating cycles
Idc block: 200 termination cycles

ENCLOSURE PARTS:

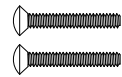

K4 6 X 25mm SCREW X 2

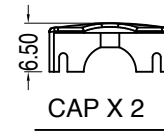
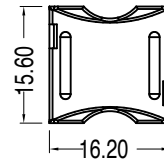

CAP X 2

T568A/B		
7 W/BR	(T568A) 1 W/GN	(T568B) W/OR
8 BR	2 GN	OR
5 W/BL	3 W/OR	W/GN
4 BL	6 OR	GN

USOC		
NC		NC
6 GN		1 W/GN
5 OR		2 W/OR
4 W/BL		3 BL

ELECTRICAL

Current rating: 1.5 Amps
Insulation resistance: 500 MOhm
Contact resistance: 20 mOhm
DC resistanc: 0.1 Ohm
Dielectric withstanding voltage: 1000 V

COMMON TOLERANCE		SHEET OF	ALL COPY RIGHTS RESERVED	
CLASS	A B	SIZE A4	REV DATE 9-27-2013	
DIMENSION		DIA mm	SCP PART #	
L<=3	±0.05 ±0.1	SCALE 3:5	122-XX	
3<L<=6	±0.05 ±0.1	DATE 2004.02.18		
6<L<=16	±0.1 ±0.15	DESIGN	JENNIFER	
16<L<=30	±0.1 ±0.2	DRAWN	CHECKED	
30<L<=120	±0.15 ±0.3			
120<L<=315	±0.2 ±0.5			